

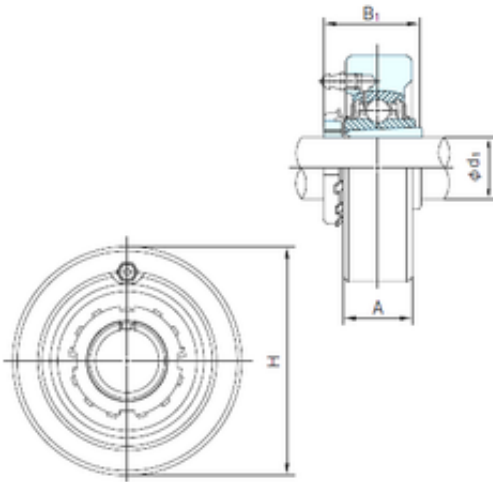

## Bearing import and Export Co., Ltd

### NACHI UKC320+H2320 bearing units

Bearing No. UKC320+H2320



Bore Diameter	90 mm
Width	260 mm
d	90 mm
A	75 mm
B1	97 mm
H	260 mm

UKC320+H2320 Bearing 2D drawings and 3D CAD models